



Instruction Manual

STVG785 /STVG785W

Please read before using this unit.

CD + Graphics and MP3+G Karaoke System with Disco Lights

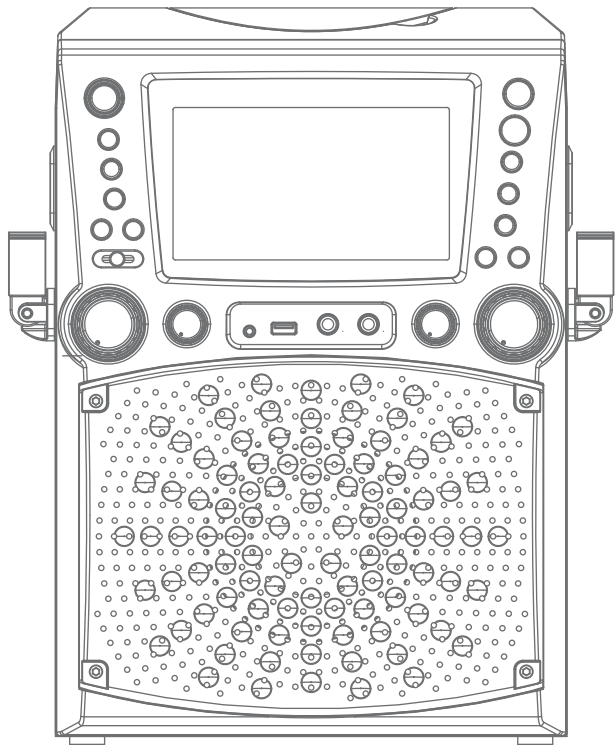

The Singing Machine® is a registered trademark of The Singing Machine Co., Inc.

WARNINGS

WARNING: TO REDUCE THE RISK OF FIRE OR SHOCK HAZARD, DO NOT EXPOSE THIS PRODUCT TO RAIN OR MOISTURE.



CAUTION

RISK OF ELECTRIC SHOCK
DO NOT OPEN



CAUTION: TO PREVENT THE RISK OF ELECTRIC SHOCK, DO NOT REMOVE COVER OR BACK. NO USER-SERVICEABLE PARTS INSIDE. REFER SERVICING TO QUALIFIED PERSONNEL.



This symbol is intended to alert you to the presence of uninsulated dangerous voltage within the product's enclosure that might be of sufficient magnitude to constitute a risk of electric shock. Do not open the product's case.



This symbol is intended to inform you that important operating and maintenance instructions are included in the literature accompanying this product.

DRIPPING WARNING

The product shall not be exposed to dripping or splashing and that no objects filled with liquids, such as vases, shall be placed on the product.

VENTILATION WARNING

The normal ventilation of the product shall not be impeded for intended use.

Warning: Changes or modifications to this unit not expressly approved by the party responsible for compliance could void the user's authority to operate the equipment.

SAFETY CERTIFICATION

This device is made and tested to meet safety standards of the FCC, requirements and compliance with safety performance of the U.S. Department of Health and Human Services, and also with FDA Radiation Performance Standards 21 CFR Subchapter J.

Main plug is used as disconnect device and it should remain readily operable during intended use. In order to disconnect the apparatus from the mains completely, the main plug should be disconnected from the main socket outlet completely.

Warnings:

- This CD player employs a laser light beam. Only a qualified service person should remove the cover or attempt to service this device, due to possible eye injury.
- The use of controls, adjustments, or procedures other than those specified herein might result in hazardous radiation exposure.
- The apparatus shall be used in an open area.

CAUTION

This compact disc player is classified as a CLASS 1 LASER product. The CLASS 1 LASER PRODUCT label is located on the rear panel.



CAUTION!

Invisible laser radiation when open and inter locks defeated. Avoid exposure to beam.

FCC IMPORTANT

Since CD circuitry may cause interference to other radio tuners nearby, switch this unit off when not in use or move it away from the affected radio tuner.

This device complies with part 15 of the FCC rules, operation is subject to the following two conditions: (1) this device may not cause harmful interference, and (2) this device must accept any interference received, including interference that may cause undesired operation.

CAN ICES-3(B)/NMB-3(B)

NOTE: This digital apparatus does not exceed the Class B limits for radio noise emissions from digital apparatus as set out in the Radio Interference Regulations of Industry Canada. These limits are designed to provide reasonable protection against harmful interference in a residential installation. This equipment generates, uses and can radiate radio frequency energy and, if not installed and used in accordance with the instructions, may cause harmful interference to radio communications. However, there is no guarantee that interference will not occur in a particular installation. If this equipment does cause harmful interference to radio or television (which can be determined by turning the equipment off), the user is encouraged to try to correct the interference by one or more of the following measure:

- Reorient or relocate the receiving antenna.
- Increase the separation between the equipment and receiver.
- Connect the equipment into an outlet on a circuit different from that to which the receiver is connected.
- Consult the dealer or an experienced radio / TV technician for help.

IMPORTANT SAFETY INSTRUCTIONS

1. Read these instructions.
 2. Keep these instructions.
 3. Heed all warnings.
 4. Follow all instructions.
 5. Do not use this apparatus near water.
 6. Clean only with dry cloth.
 7. Do not block any ventilation openings. Install in accordance with the manufacturer's instructions.
 8. Do not install near any heat sources such as radiators, heat registers, stoves, or other apparatus (including amplifiers) that produce heat.
 9. Do not defeat the safety purpose of the polarized or grounding-type plug. A polarized plug has two blades with one wider than the other. A grounding type plug has two blades and a third grounding prong. The wide blade or the third prong are provided for your safety. If the provided plug does not fit into your outlet, consult an electrician for replacement of the obsolete outlet.
 10. Protect the power cord from being walked on or pinched particularly at plugs, convenience receptacles, and the point where they exit from the apparatus.
 11. Only use attachments/accessories specified by the manufacturer.
 12. Use only with the cart, stand, tripod, bracket, or table specified by the manufacturer, or sold with the apparatus. When a cart is used, use caution when moving the cart/apparatus combination to avoid injury from tip-over.
 13. Unplug this apparatus during lightning storms or when unused for long periods of time.
 14. Refer all servicing to qualified service personnel.
- Servicing is required when the apparatus has been damaged in any way, such as power-supply cord or plug is damaged, liquid has been spilled or objects have fallen into the apparatus, the apparatus has been exposed to rain or moisture, does not operate normally, or has been dropped.



BATTERY PRECAUTIONS

The precautions below should be followed when using battery in the wireless microphone.

1. Use only the size and type of batteries specified.
2. Be sure to follow the correct polarity when installing the battery as indicated in the battery compartment. Reversed battery may cause damage to the device.
3. If the device is not to be used for a long period of time, remove the battery to prevent damage or injury from possible battery leakage.
4. Rechargeable battery is to be removed from the product before being charged.
5. Rechargeable battery is only to be charged under adult supervision.
6. Exhausted battery is to be removed from the product.

Class II equipment symbol



This symbol indicates that the unit has a double insulation system.

CONTROL LOCATIONS

FRONT VIEW

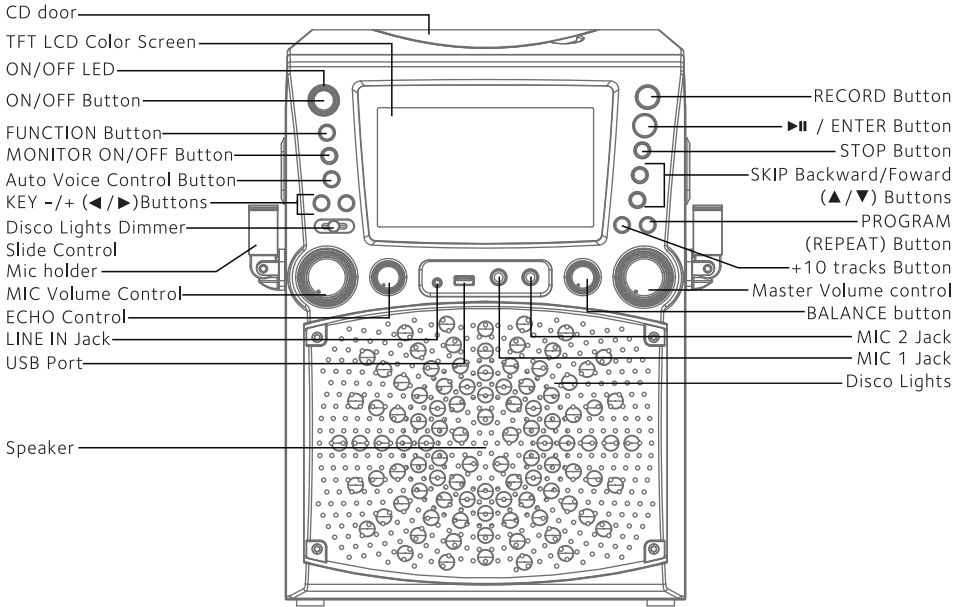

REAR VIEW

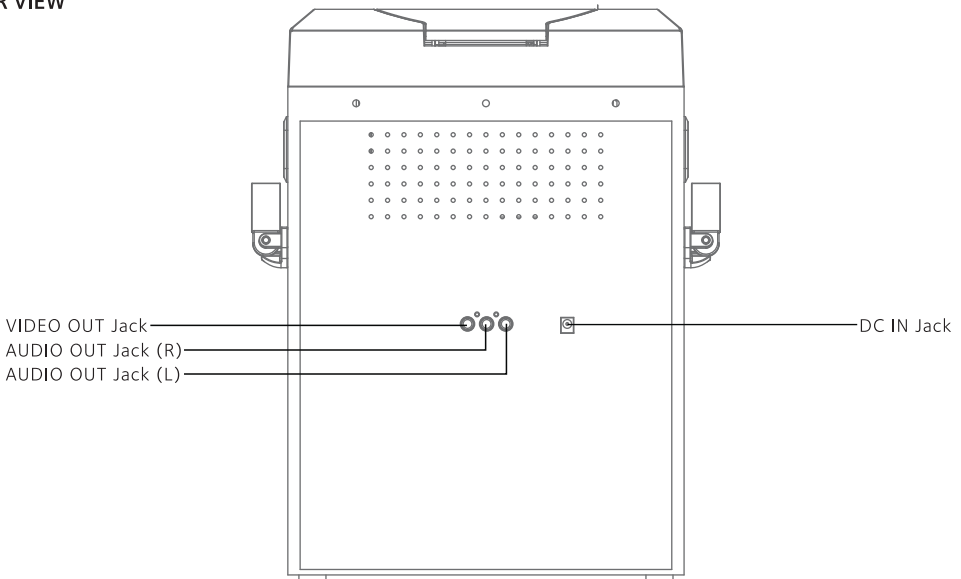

MAKING THE CONNECTIONS

CONNECTING POWER

Insert the DC plug of the power adapter into the DC 12V jack on the unit. You can power the system from a standard AC outlet by using the supplied Power Adapter (The adapter operates on AC 100V-240V/50Hz-60Hz \ominus - \oplus).

CAUTION:

- The included AC adapter is for use with this unit only. Do not use it with other equipment.
- When the adapter is plugged in, the apparatus is not completely disconnected from the mains, even when the power is turned off.

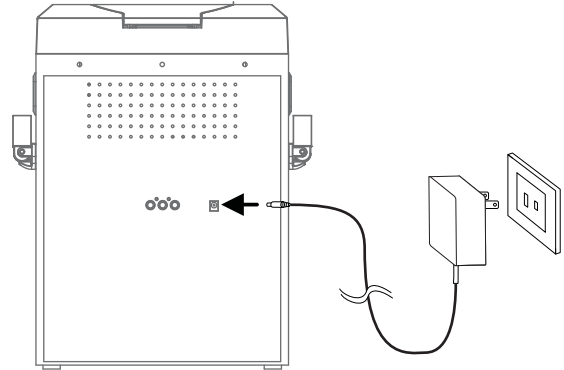

CONNECTING TO YOUR TV

Your Singing Machine is designed to connect to your TV the same way you would connect most video cameras, DVD players or video game consoles.

Please follow the steps below to display lyrics on the TV screen:

- (1) Locate the multi-colored RCA cables.
- (2) Connect the RCA video cable (Yellow) to the VIDEO OUT jack and the audio cables (White and Red) to the AUDIO OUT jacks located on the back of your Singing Machine.
- (3) Connect the opposite end of the RCA video cable (Yellow) to the VIDEO IN jack and the audio cables (White and Red) to the AUDIO IN jacks on your TV.

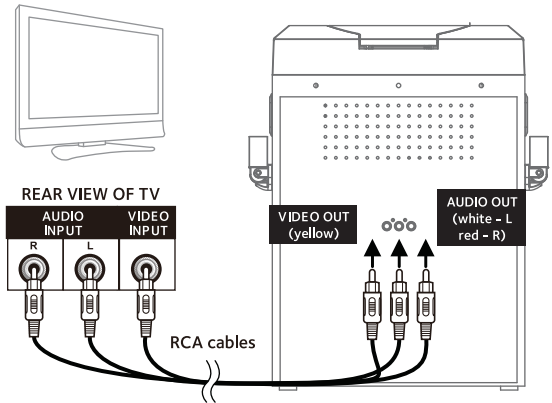

LINE IN CONNECTION

Your Singing Machine has the capability of playing your digital music device (e.g. iPod/MP3 player, etc.) by connecting it to the LINE IN jack on your Singing Machine and simply powering the device on.

You should have to connect your device by using an appropriate cable (\varnothing 3.5mm audio cable not included).

LINE IN function can be switched ON by pressing FUNCTION button until LINE IN display on the LCD screen.

MASTER VOLUME

Rotate the MASTER VOLUME control to obtain the desired sound level.

Warning - To avoid excessive over amplified sound output, it is recommended that the volume control is initially adjusted to one third or less and then increased if required.

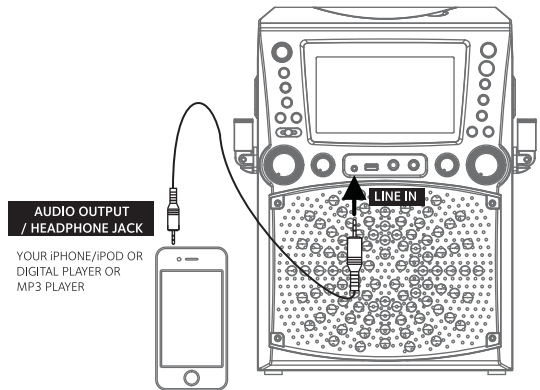

OPERATION

This unit is designed to play CDs, CD+Gs and MP3+G discs bearing the identification logo respectively. If the disc does not conform to the standard, it may not play properly.



TURNING POWER ON/OFF

To turn on the unit, press the ON/OFF button, the ON/OFF LED indicator will light up.

To turn it off, press the ON/OFF button again, the ON/OFF LED indicator will turn off.

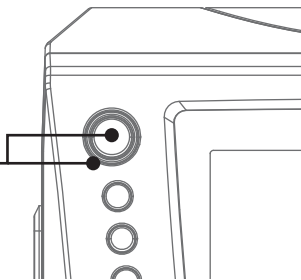

LOADING A DISC

Open the CD door, place a CD, CD+G or MP3+G disc in the compartment with the printed side facing upward and the shiny side facing down.

Gently close the CD door. Press the FUNCTION button until it appears **CD** on the LCD display, the total number of tracks will display on LCD display. (If a disc is not loaded in the CD compartment, the LCD display will display **NO DISC**.)

NOTE:

- Never place anything except a compact disc on the disc tray. Foreign objects can damage the unit.
- Only place one disc on the tray at a time.

PLAYING USB MEDIA

This unit is ready for MP3/MP3+G playback by USB Flash Drive.

After you've downloaded your Karaoke music (MP3/MP3+G files) onto your USB Flash Drive; turn the unit ON and insert the USB Flash Drive into the USB port. Press the FUNCTION button until it appears **READ USB** on the LCD display, the total number of MP3 tracks will display on LCD display.

NOTE:

1. In order to begin playing music from your USB Flash Drive, make sure the function on your Singing Machine is set to USB mode. See FUNCTION SELECT below for more information.
2. Always turn on the unit before inserting your USB Flash Drive.

(To download MP3+G Karaoke music, please refer to the **WHERE TO DOWNLOAD MP3+G KARAOKE MUSIC** page.)

IMPORTANT: To play downloaded MP3+G files on your USB Flash Drive, you must first UNZIP the file before transferring to your USB Flash Drive.)

After USB drive is plugged in the Singing Machine, MP3 menu will show the MP3 (or MP3+G) files you have downloaded. You can press ◀, ▶, ▲, ▼ and ENTER buttons to navigate your desired track.

FUNCTION SELECT

This unit has different functions. You can select between CD/USB/LINE IN.

To switch function, press the FUNCTION button.

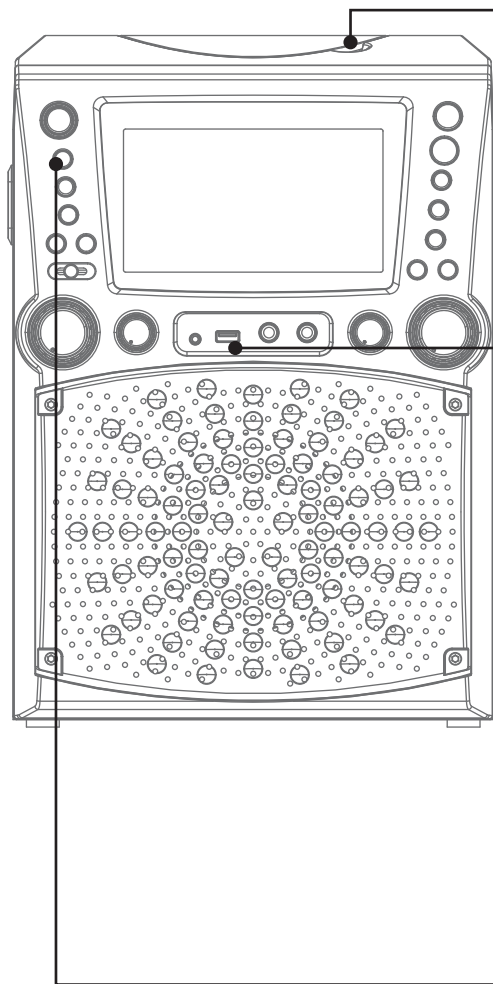

OPERATION

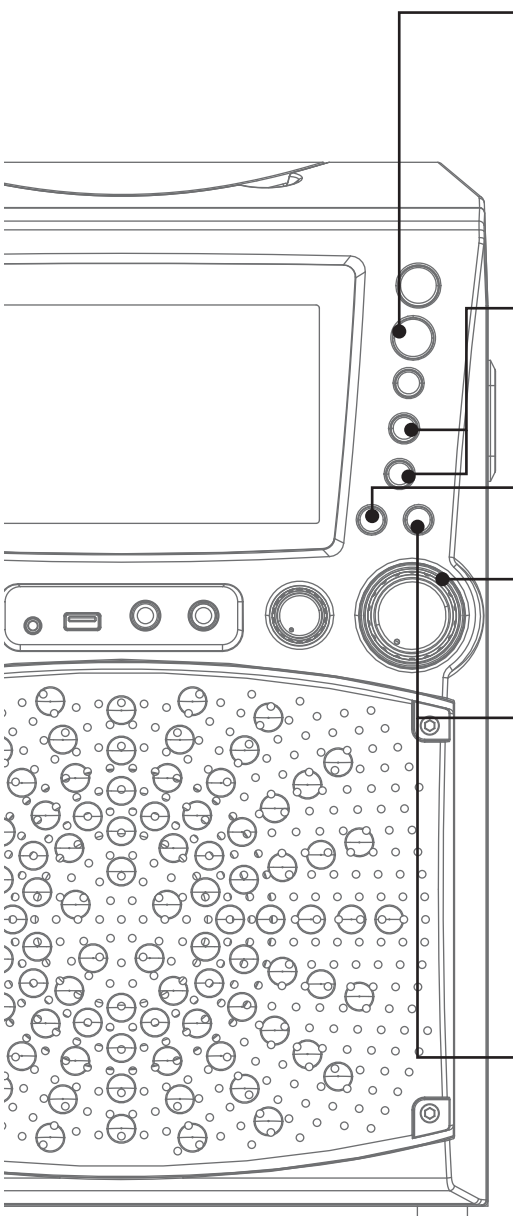

PLAY/PAUSE

Adjust the MASTER VOLUME control on your unit to a comfortable level.

Press the PLAY/PAUSE button. The first track will display on the LCD display.

To temporarily stop playing, press the PLAY/PAUSE button. To resume play, press this button again.

NOTE: Pressing pause repeatedly when a CD+G is playing may cause distorted lyrics on your screen. Any distortion will remain on the screen until it is refreshed either during an instrumental break or when the song is stopped and/or when the song is started from the beginning.

SKIP AND SEARCH

You can always skip forward or back to your desired track number by pressing the SKIP buttons. When playing any audio CD, press and hold the SKIP button. The CD will search at high speed in the forward or backward direction. Normal play will continue when you release the button.

SKIP FORWARD 10 TRACKS



During MP3 playback, you can press +10 TRACKS button will skip forward quicker.

MASTER VOLUME

Rotate the MASTER VOLUME control to obtain the desired sound level.

Note: The MIC volume must be adjusted simultaneously with the master volume level.

REPEAT

To repeat the current track, press the PROGRAM(REPEAT) button once during playback. The  icon will appear on the LCD display and the current track will be repeated. Press the button twice,  icon will appear and all MP3 tracks inside the current folder will be repeated continuously. To repeat all tracks of disc/USB press the REPEAT(REPEAT) button again, the  icon will display on the LCD display.

To deactivate the repeat function, you can repeat the above procedure with  on LCD display or simply stop the playback and open the CD door.

NOTE: Repeat FOLDER/DIRECTORY function is not available for normal music CD/CD+G playback.

PROGRAM

Use the PROGRAM(REPEAT) button to program and play songs in a pre-selected order.

1. Programming should be done in the STOP mode only. Press the PROGRAM(REPEAT) button, the "PRG P01:XX" (XX - total number of tracks) will show on the monitor. Then press the SKIP buttons to select a desired track.

2. Press the PROGRAM button to confirm the entry. You can repeat the same steps up to a maximum of 20 tracks.

3. Press the PLAY button after you've completed programming and you are ready to start singing.

Press the STOP button twice to clear all the programmed entries.

OPERATION

MONITOR ON/OFF

Press the MONITOR button to ON if you want to display CD+G or MP3+G lyrics on the Singing Machine's monitor.

KARAOKE FUNCTIONS

Sing along with the music by plugging in the provided microphone into either one of the microphone jacks on the unit.

WARNING: *Tapping or dropping the microphone can permanently damage your microphone. Do not swing the microphone around by the cord.*

DISCO LIGHT

To illuminate the disco light and get your desired lighting effect, slide the dimmer slide control from the lowest position to your desired level.

MIC VOLUME

Adjust the MIC VOLUME control to a desired level to obtain the best performance.

WARNING: *To avoid microphone feedback, do not hold the microphone too close to the Singing Machine speaker.*

KEY CONTROL

Press the KEY +/- button to adjust the KEY control so as to obtain the best voice to your favorite songs.

AUTO VOICE CONTROL (MULTIPLEX DISCS ONLY)

Allows you to replace the lead singers' voice with your own when playing a multiplex recording. The vocals on the multiplex recording will be muted when using the microphone. When the microphone is not in use, the pre-recorded vocals will resume on a multiplex disc. The Auto Voice Control can be activated by pressing the A.V.C. ON/OFF button.

ECHO

Adjust the ECHO control to enhance the singers' voice for a concert hall effect.

BALANCE

Allows you to eliminate the lead singers' voice by rotating the knob to the left when playing a multiplex recording or eliminate the music when rotating the knob to the right.

NOTE: *When playing an audio CD or music only recording, the balance knob will shift the recording to the right or left speaker.*

RECORDING ON A USB DRIVE

During CD mode, insert a USB drive into the USB port. Select your favorite track and press PLAY button to start. Now, you can press the RECORD button; the LCD screen will show **REC** and the track progression in percentage. Sing or speak into the microphone and your voice will record along with the music and video (if video is present) onto the USB. When done recording, press the RECORD button again to stop recording.

NOTE:

- to play the recording, repeatedly press the FUNCTION button to select USB mode and then select the file under the RECORD sub-menu.
- this unit can only record CD/CD+G with voice.

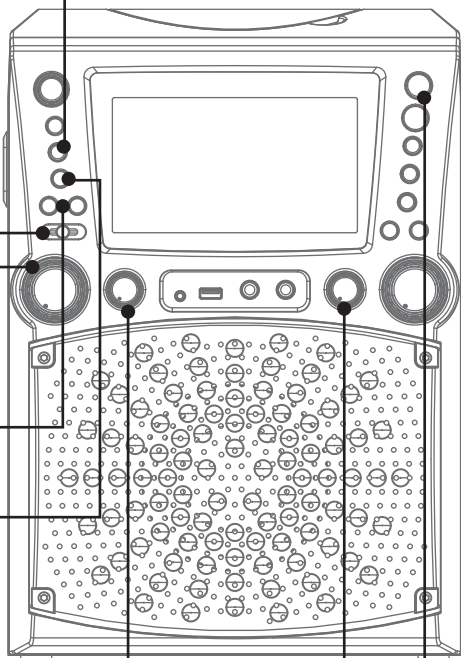

OPERATION

Where to Download MP3+G Files

HELPFUL HINTS:

The .mp3 and .CD+G files are delivered for download in a single, compressed MP3+G.zip file. The MP3+G file cannot be played as a .zip file on a USB flash drive. To play karaoke songs using a USB flash drive, the MP3+G .zip file must be unzipped as follows:

- Connect a USB flash drive to your computer
- Download the MP3+G file from your Digital Locker and save the .zip* file to a folder on your computer
- Double click the .zip file to open the .zip (you will see the .mp3 and .CD+G files)
- Drag and drop the .mp3 and .CD+G files to the USB flash drive
- Remove (eject) the USB flash drive from your computer

Turn on the Singing Machine and connect the USB flash drive

To purchase and download karaoke music, please visit <http://store.singingmachine.com> to access over 12,000 of your favorite karaoke songs. You will need a USB flash drive (not included) to transfer the downloads to this unit. Follow these easy steps:

- 1 Go to <http://store.singingmachine.com> using your internet browser, and then register.
- 2 Select and purchase your favorite karaoke music from the Singing Machine Download Store.
- 3 Download your selected purchase(s) from the Singing Machine Digital Locker to your USB flash drive. (see Helpful Hints)
- 4 Insert the USB flash drive into the control panel as shown on page 5 and enjoy!

Note: Your downloaded songs can also be burned to a blank CDR/CDRW.

FAQ

- Where can I get additional help with the file formats?

While on the Singing Machine Store's web page, simply click FILE FORMATS at the lower left.

The screenshot shows the Singing Machine Karaoke Downloads website. At the top, there's a navigation bar with 'THE SINGING MACHINE' logo, 'Karaoke Downloads', and social media links. Below this is a search bar and a sidebar with filters for 'All Songs', 'All Artists', 'Genres', 'Languages', 'Eras', and 'Known Editions'. The main content area is titled 'The SMC Karaoke Manager' and features several sections: 'Most Popular' (listing songs like 'I Wanna Dance with Somebody'), 'New Releases', 'Top Artists', 'Top Rock Songs', 'Top Pop Songs', and 'Top Country Songs'. A 'Cart' section on the right shows a total of \$5.99. A promotional banner for 'Karaoke Downloads!' is also visible.

TROUBLE SHOOTING GUIDE

If you have followed the instructions and are having difficulty operating the unit; locate the problem listed on the left hand column below and check the corresponding possible cause column to locate and remedy the problem.

PROBLEM	POSSIBLE CAUSE	SOLUTION
No power when ON/OFF button is ON.	No power plug connection at the AC outlet.	Insert the power plug into the wall outlet.
No power when plugged in.	The AC outlet may not have power.	Check the outlet with a working lamp or other electrical appliance.
	DC plug is not secure on the back of the unit.	Securely plug cord into the back of the unit.
No sound.	Volume control is set to minimum.	Turn up the volume.
CD PLAYER does not work normally.	Disc is inserted upside down.	Insert disc correctly.
	Disc is dirty.	Wipe disc in a straight line from the center to the edge with a soft, lint free cloth.
	Disc is scratched.	Use a new disc.
	Disc is warped.	Use a new disc.
	Lens is dirty.	Wipe the lens inside the CD compartment with a clean dry cotton cloth or run a CD lens cleaner thru the CD compartment.
	Moisture has formed inside the CD deck.	Wait about 20 to 30 minutes to let it dry out.
	The Singing Machine needs to be reset.	Power the system OFF and disconnect the machine from electrical outlet for 30 seconds.
No sound - If audio is going through TV or home stereo.	Source Selection on your TV or home stereo is not set properly.	Select AUX IN as the source for your TV or home stereo.
	Improper Connection to stereo system or PA.	Follow direction on "MAKING THE CONNECTIONS".
	Volume control on TV or home stereo is set to minimum.	Turn up the volume on the TV or home stereo.

TROUBLE SHOOTING GUIDE

PROBLEM	POSSIBLE CAUSE	SOLUTION
Lyrics do not appear on the TV.	Video cable is not connected properly to the TV.	Follow direction on "MAKING THE CONNECTIONS".
	TV does not have video line input.	Connect from Video out of the Singing Machine to the Video in on your DVD player. Confirm you are playing a CD+G disc or a MP3+G disc.
	Source has not been selected on your TV.	Use your TV Remote to select the corresponding VIDEO input.
No sound from mic.	Mic volume control.	Adjust mic volume to max, and then re-adjust to a comfortable level.
	MIC is OFF.	Switch Mic to the ON position.
	The MIC is not connected to the MIC jack securely.	Securely connect the MIC to the MIC jack.
	Master Volume is set to Minimum.	Adjust the Master Volume knob to comfortable level.
	Microphone is not positioned correctly.	Speak or sing into the top of the microphone; no more than 1" away from your mouth.
While playing a CD+G and singing with the microphone, the music or vocals cut out.	AVC is activated.	Switch off AVC.
	You are playing a music only track.	Play track that includes music and vocal.
Music and vocals are playing in a high speed.	Key control is set too high.	Minimize/adjust the key control to display H on the LCD display.
No sound or low volume from the microphone.	Echo is set to minimum.	Increase the echo level as needed.
While playing a CD+G track with music and vocals, only music or vocals play.	Balance is set either to the left or right.	Adjust balance to middle.

SPECIFICATIONS

AUDIO SECTION: OUTPUT POWER (MAXIMUM) OUTPUT IMPEDANCE	10 WATTS (RMS) 4 OHMS
CD PLAYER SECTION: FREQUENCY RESPONSE SIGNAL-TO-NOISE RATIO NUMBERS OF PROGRAMS SAMPLING SYSTEM	100 Hz - 20 KHz 50 dB (A-WTD) 20 STEPS RANDOM ACCESS PROGRAMMING 8 TIMES OVER SAMPLING
LINE IN SECTION:	Ø 3.5mm stereo headphone jack
MICROPHONE:	-74 dB 600 OHMS IMPEDANCE WITH Ø6.3mm DYNAMIC MICROPHONE
POWER SECTION:	DC 12V $\overline{=}$ 2A \ominus \oplus
DIMENSION (W X D X H):	11.4 x 9.5 x 16.4 inches / 29.0 x 24.1 x 41.7 cm
WEIGHT:	7.9 lbs / 3.6 kgs

Specifications are typical. Individual units might vary and are subject to continuous improvement without notice and/or incurring any obligation.

The Singing Machine Company, Inc.

785/W-1307-ENG01

4060 E Jurupa Street, Unit B
Ontario, CA 91761-1413 USA

PRINTED IN CHINA

VISIT OUR WEBSITE www.singingmachine.com